

INSTRUCTION MANUAL

650Line Intensifier3™ Series Focus Free

HTD8FFI

(Weatherproof Color Dome Camera)

HTB11FFI

(Weatherproof Color Bullet Camera)

HT7248FFI

(Weatherproof Color Dome Camera)



Contents

● Contents.....	1
● Precautions	2, 3
● Safety Instructions	4
● Package Contents.....	5
● Camera Installation	6-11
● Specifications.....	12-14
● Camera Dimension	15, 16
● Features.....	17, 18
● OSD Menu Details	19-30
● Trouble Shooting.....	31

Precautions

Do not install the camera in extreme temperature conditions.

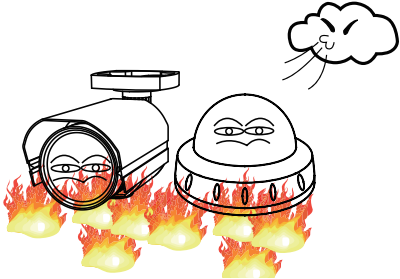

Only use the camera under conditions where temperatures are between -10°C and $+50^{\circ}\text{C}$. Be especially careful to provide ventilation when operating under high temperatures.

Do not install the camera under unstable lighting conditions.

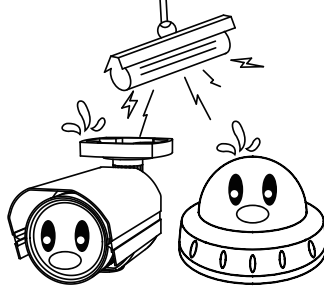

Severe lighting change or flicker can cause the camera to work improperly.

Do not touch the front lens of the camera.

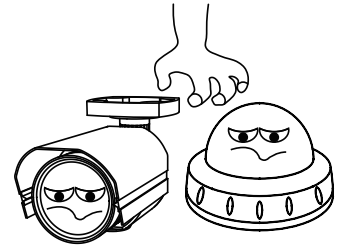

This is one of the most important parts of the camera. Be careful not to leave fingerprints on the lens cover.

Never keep the camera pointed directly at strong light.

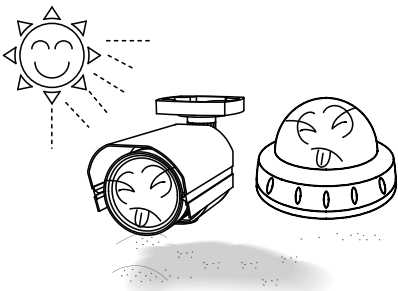

It can cause malfunctions to occur.

Do not drop the camera or subject it to physical shocks.

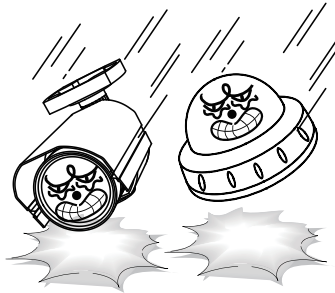

Severe lighting change or flicker can cause the camera to work improperly.

Do not expose the camera to radioactivity.

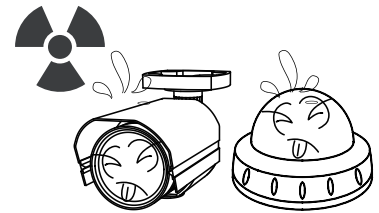

If exposed to radioactivity the CCD will fail.

NOTE

* If the camera is exposed to spotlight or object reflecting strong light, smear or blooming may occur.

* please check that the power satisfies the normal specification before connecting the camera.

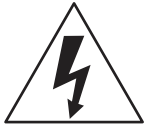

The lightning flash with an arrowhead symbol, within an equilateral triangle is intended to alert the user to the presence of uninsulated dangerous voltage within the product's enclosure that may be of sufficient magnitude to constitute a risk of electric shock to persons.



The exclamation point within an equilateral triangle is intended to alert the user to the presence of important operating and maintenance (servicing) instructions in the literature accompanying the appliance.

INFORMATION - This equipment has been tested and found to comply with limits for a Class A digital device, pursuant to part 15 of the FCC Rules & CE Rules. These limits are designed to provide reasonable protection against harmful interference when the equipment is operated in a commercial environment. This equipment generates, uses, and can radiate radio frequency energy and, if not installed and used in accordance with the instruction manual, may cause harmful interference to radio communications. Operation of this equipment in a residential area is likely to cause harmful interference in which case the user will be required to correct the interference at their own expense.

WARNING - Changes or modifications not expressly approved by the manufacturer could void the user's authority to operate the equipment.

CAUTION : To prevent electric shock and risk of fire hazards:
☞ Do NOT use power sources other than those specified.

This installation should be made by a qualified service person and should conform to all local codes.

Safety Instructions

Precautions for use

- ❶ This camera should be installed by qualified personnel only
- ❶ There are no user serviceable parts inside
- ❶ Do not disassemble this camera other than to make initial adjustments
- ❶ Use a UL approved regulated 24 volt AC or 12 volt DC power supply
- ❶ Use appropriate low voltage power cable to prevent fire or electrical shock
- ❶ Please insure that your installation area can support the weight of the camera

Please handle this camera carefully :

- ❶ Do not use a strong or abrasive detergent when cleaning the camera
- ❶ Do not install near cooling or heating device

Package Contents

Please make sure that the following items are included in the Package:

1) HTD8FFI

- 1 Video Test Connector, Power Jack
- 2 Wrenches
- Set Screw
 - 3 Tapping Screws 4x25
 - 2 Hexagon Socket Screws M6x20

2) HTB11FFI

- 1 Video Test Connector, Power Jack
- 1 Bracket Base
- 2 Wrenches
- Set Screw
 - 4 Tapping Screws 4x25
 - 4 Hexagon Socket Screws M5x10

3) HT7248FFI

- 1 Video Test Connector, Power Jack
- 1 Chameleon Cover
- 1 Wrench
- Set Screw
 - 3 Tapping Screws 4x40
 - 3 Plastic Anchor

CAMERA INSTALLATION

CONNECT POWER CABLE

1. WHEN USING 12 VOLTS DC (constant voltage 500 mA)

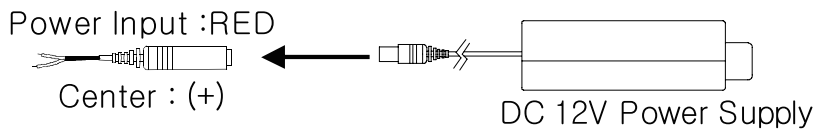

2. WHEN USING 24 VOLTS AC (40 Volt Amps)

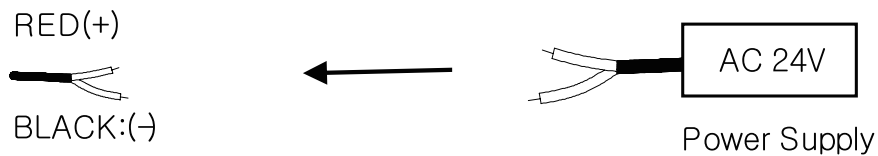

3. CONNECT VIDEO CABLE

- CONNECT BNC CABLE TO THE BNC JACK.

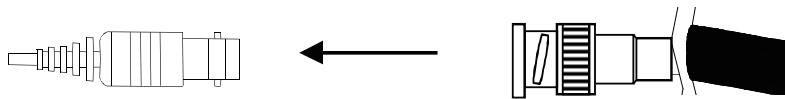

4. CONNECT Alarm output (Relay output)

- Connect (+ , COM) for Positive activation and (- , COM) for Negative activation of External Alarm Device when Motion Detection is 'ON' in the camera.

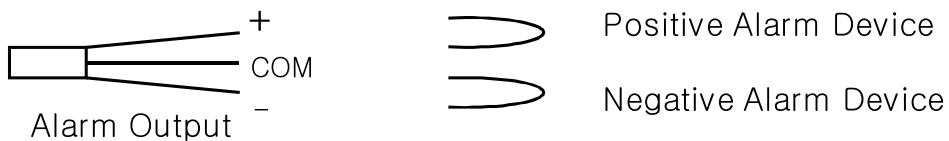

5. CONNECT RS-485 CABLE

- Connect 2Wire Cable to the 485 port as below.

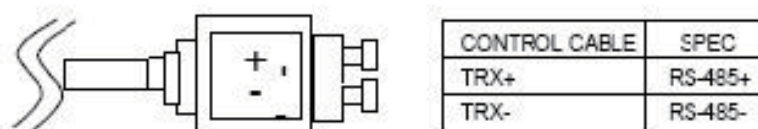

CAMERA INSTALLATION

Compatibility

1) HTD8FFI

INTWM

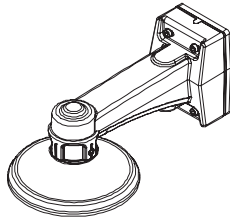

INTPM

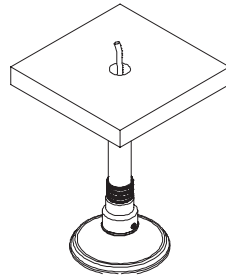

JB03TG

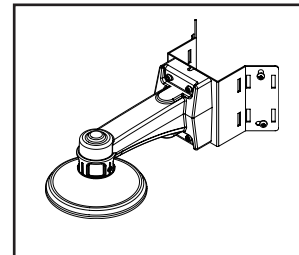
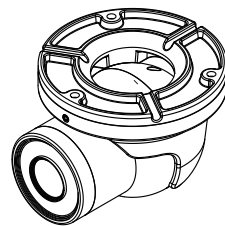
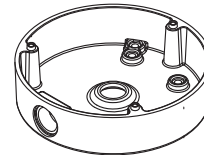

2) HTB11FFI

CVCJBB

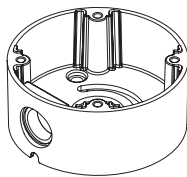

INTJBS

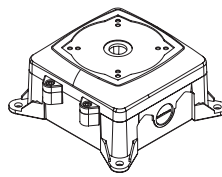

INTCM

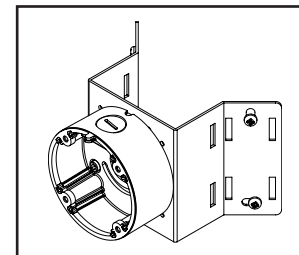
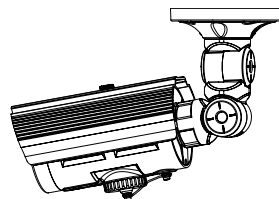
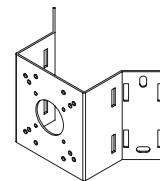

CAMERA INSTALLATION

Compatibility

3) HT7248FFI

INTWM

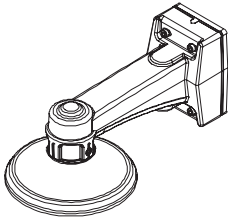

INTPM

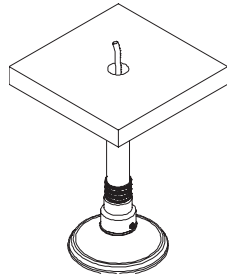

CVCJBD

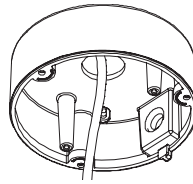

DFM

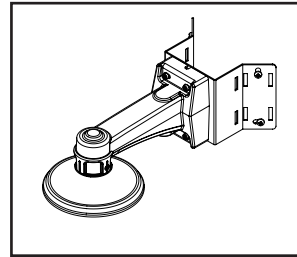
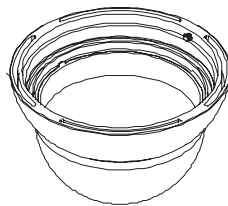
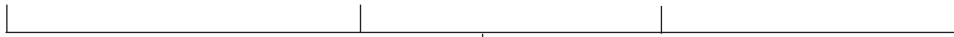
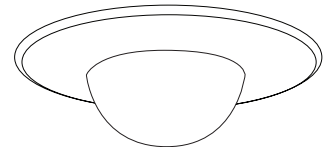

CAMERA INSTALLATION

1. HTD8FFI

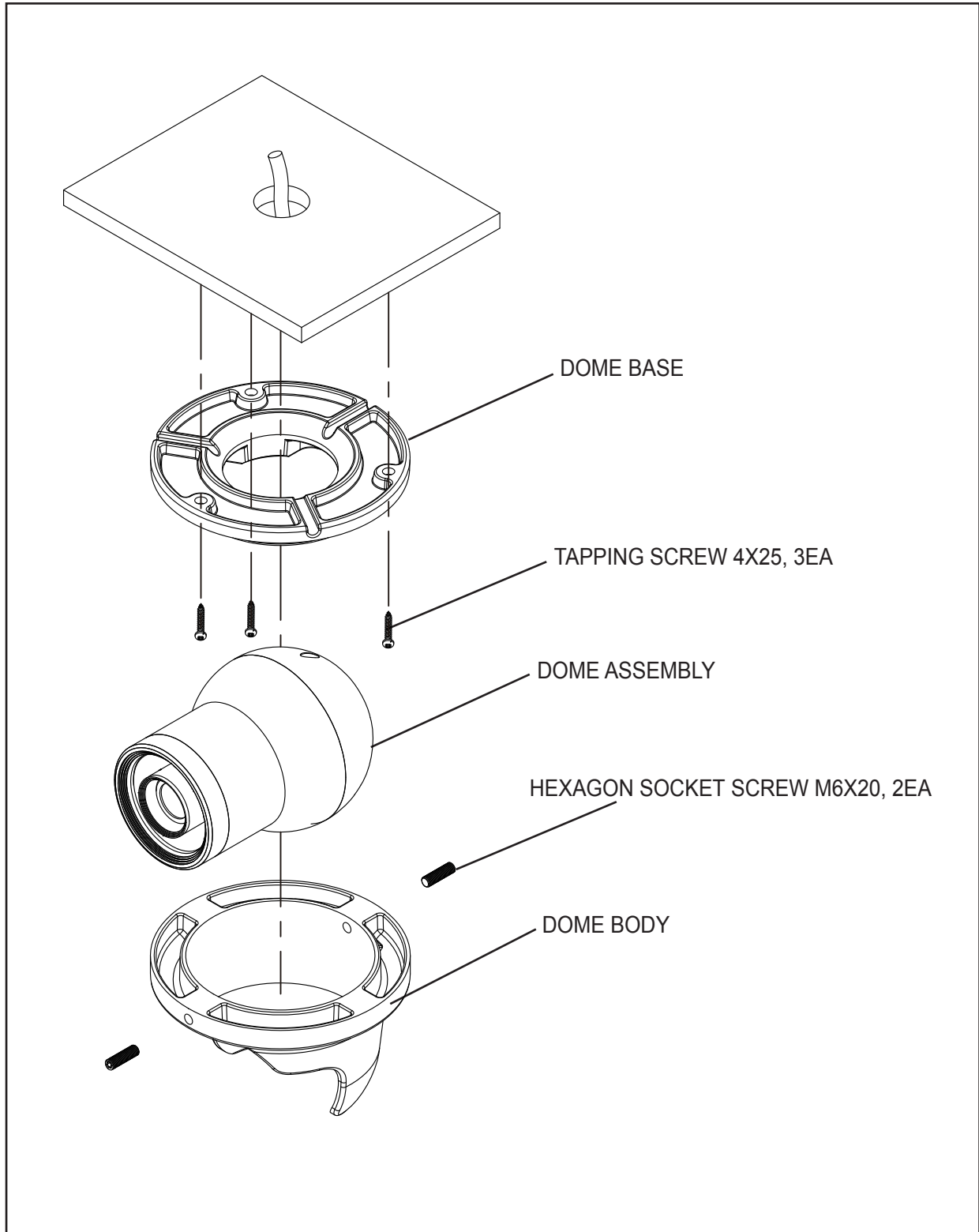

CAMERA INSTALLATION

2. HTB11FFI

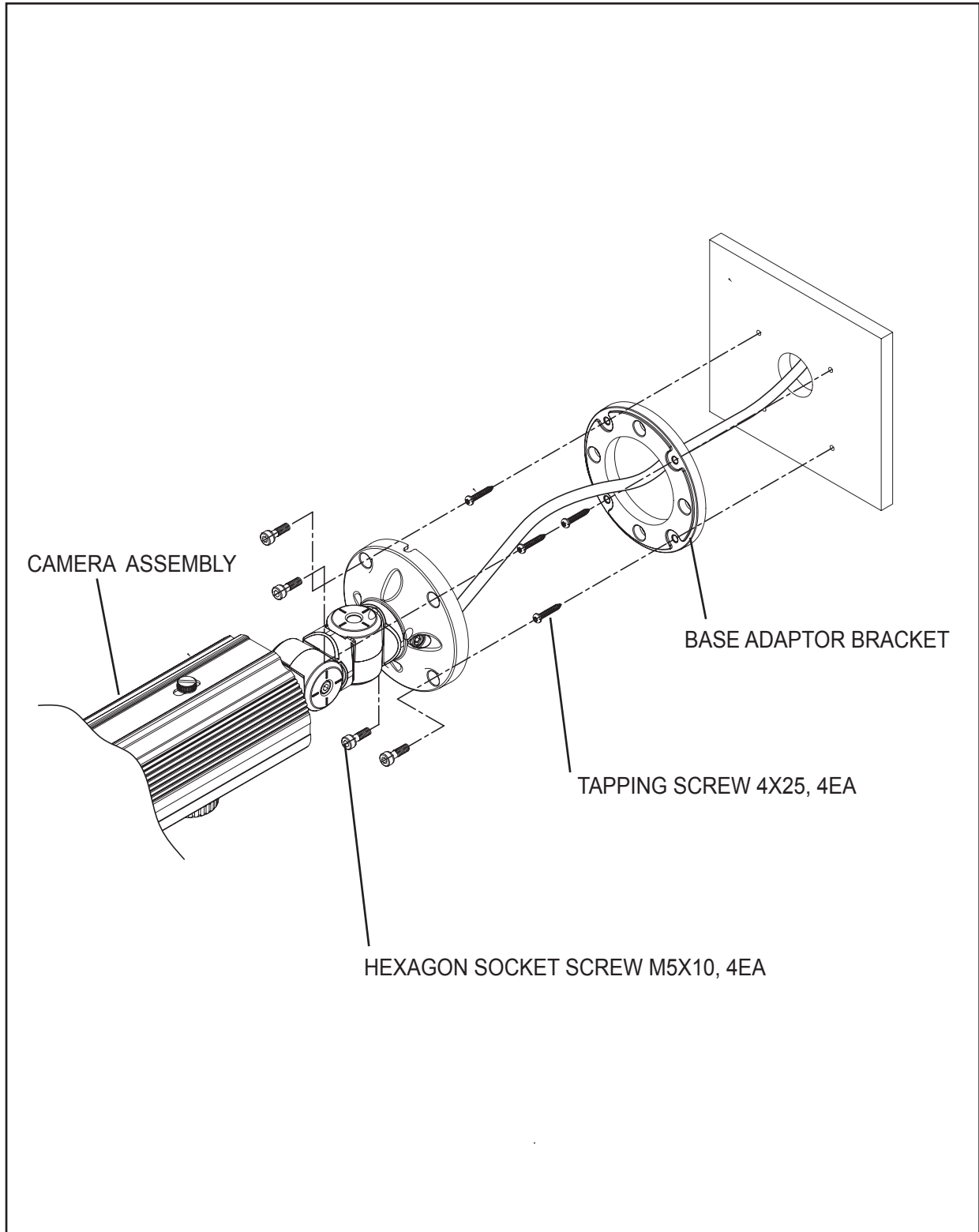

CAMERA INSTALLATION

3. HTB7248FFI

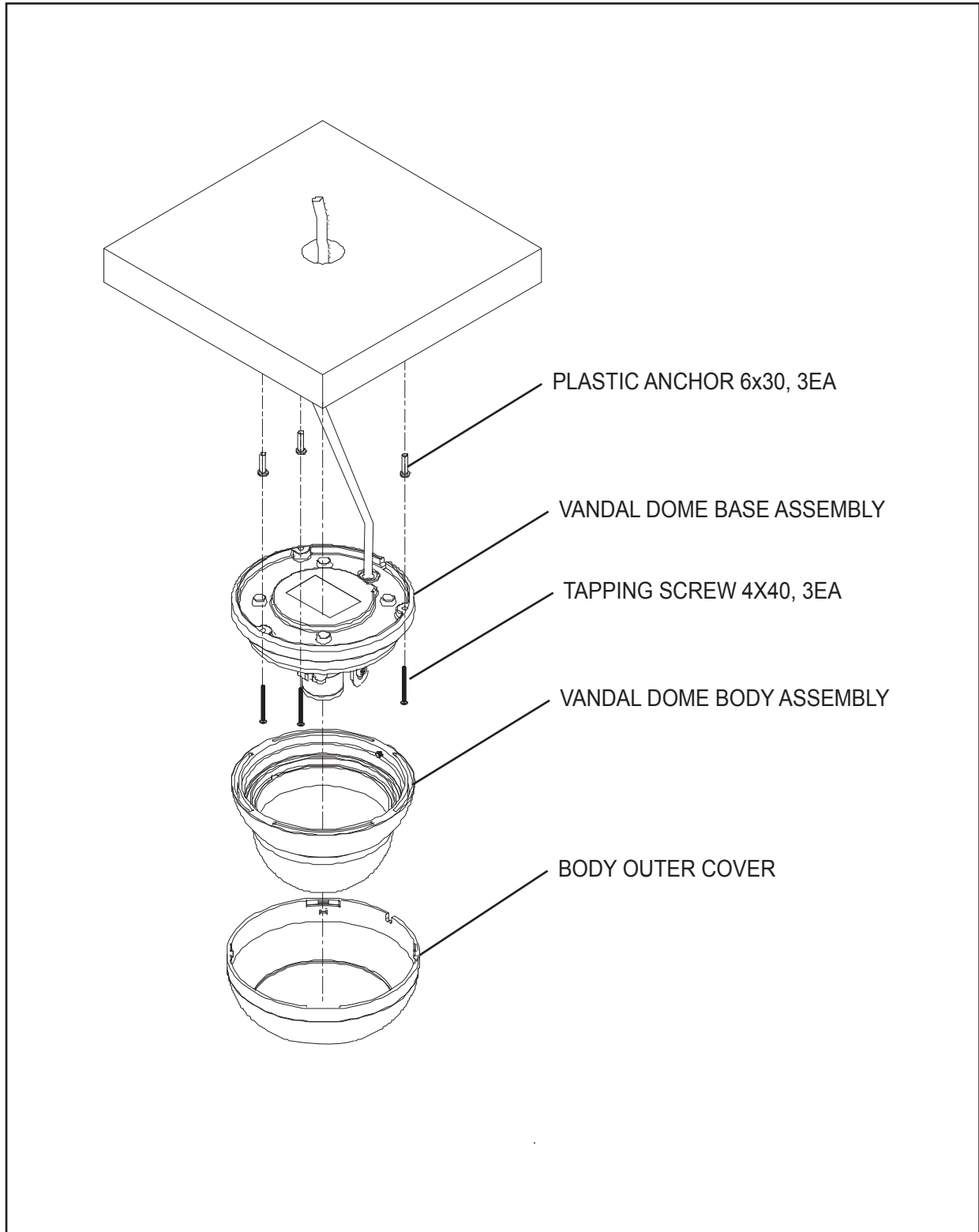

650 Line Intensifier3

(Weatherproof Color Dome Camera)

Focus free AI Motorized zoom Lens(2.8-10mm)

Focus Free



■ **HTD8FFI**

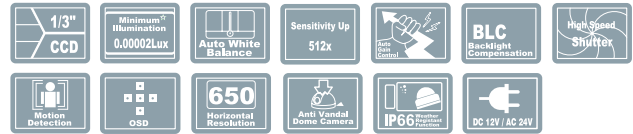

SPECIFICATIONS

MODEL	HTD8FFI
Image Pick-Up Device	1/3" Sony Super HAD II CCD
TV System	NTSC, PAL
Total Pixels	NTSC=811(H) * 508(V) / PAL=795(H) * 596(V)
Effective Pixels	NTSC=768(H) * 494(V) / PAL=752(H) * 582(V)
Scanning Frequency	NTSC=15.734KHz(H) & 59.94Hz(V) / PAL=15.625KHz(H) & 50.00Hz(V)
Scanning System	2:1 Interlace
Synchronization	Internal
Resolution	650TV Lines
Minimum Illumination	CDS OFF: 0.15 Lux, CDS ON: 0.00002 Lux
S/N Ratio	More than 52dB
Video Output	CVBS: 1.0Vp-p / 75Ω
Electronic Shutter Speed	NTSC=(1/60sec~1/120,000sec) / PAL=(1/50sec~1/120,000sec)
OSD	Available
WDR	On / Off (Level adjustable)
BLC	BLC / HLC / OFF
Day & Night	Color / BW / AUTO
Gain Control	Low / High / Off
White Balance	ATW / Outdoor / Indoor / Manual / AWC (1,700°K ~ 11,000°K)
Intensify	Auto / Off (Selectable x2 ~ x512)
Motion Detection	On / Off (8 Programmable Zones)
Privacy Masking	On / Off (12 Programmable Zones)
SPECO DNR	On / Off (Level adjustable)
Digital Zoom	On / Off (x1 ~ x16)
DIS (Digital Image Stabilization)	On / Off
Sharpness	On / Off (Level adjustable)
Flip / Mirror	On / Off
Power Supply	DC 12V / AC24V(Dual Voltage)
Power Consumption	DC 12V 400mA / AC24V 170mA
Lens	Focus free AI Motorized zoom Lens(2.8-10mm)
RS485(Optional)	PELCO-D, PELCO-P, BOSCH, HONEYWELL, VICON, PANA, STW(SPD)
Operational Temp.	-4°F~+140°F RH 95% Max
Storage Temp.	-4°F~+140°F RH 95% Max
Dimension	5.47" (Dia) * 4.36" (H)
Weight	3.08 lbs

650 Line Intensifier³

(Weatherproof Color Bullet Camera)

Focus free AI Motorized zoom Lens(2.8-10mm)



■ HTB11FFI



SPECIFICATIONS

MODEL	HTB11FFI
Image Pick-Up Device	1/3" Sony Super HAD II CCD
TV System	NTSC, PAL
Total Pixels	NTSC=811(H) * 508(V) / PAL=795(H) * 596(V)
Effective Pixels	NTSC=768(H) * 494(V) / PAL=752(H) * 582(V)
Scanning Frequency	NTSC=15.734KHz(H) & 59.94Hz(V) / PAL=15.625KHz(H) & 50.00Hz(V)
Scanning System	2:1 Interlace
Synchronization	Internal
Resolution	650TV Lines
Minimum Illumination	CDS OFF: 0.15 Lux, CDS ON: 0.00002 Lux
S/N Ratio	More than 52dB
Video Output	CVBS: 1.0Vp-p / 75Ω
Electronic Shutter Speed	NTSC=(1/60sec~1/120,000sec) / PAL=(1/50sec~1/120,000sec)
OSD	Available
WDR	On / Off (Level adjustable)
BLC	BLC / HLC / OFF
Day & Night	Color / BW / AUTO
Gain Control	Low / High / Off
White Balance	ATW / Outdoor / Indoor / Manual / AWC (1,700°K ~ 11,000°K)
Intensify	Auto / Off (Selectable x2 ~ x512)
Motion Detection	On / Off (8 Programmable Zones)
Privacy Masking	On / Off (12 Programmable Zones)
SPECO DNR	On / Off (Level adjustable)
Digital Zoom	On / Off (x1 ~ x16)
DIS (Digital Image Stabilization)	On / Off
Sharpness	On / Off (Level adjustable)
Flip / Mirror	On / Off
Power Supply	DC 12V / AC24V(Dual Voltage)
Power Consumption	DC 12V 400mA / AC24V 170mA
Lens	Focus free AI Motorized zoom Lens(2.8-10mm)
RS485(Optional)	PELCO-D, PELCO-P, BOSCH, HONEYWELL, VICON, PANA, STW(SPD)
Operational Temp.	-4°F~+140°F RH 95% Max
Storage Temp.	-4°F~+140°F RH 95% Max
Dimension	3.46"(W) * 4.01"(H) * 11.02"(D)
Weight	3 lbs

650 Line Intensifier3

(Weatherproof Color Dome Camera)

Focus free AI Motorized zoom Lens(2.8-10mm)

Focus Free



■ HT7248FFI

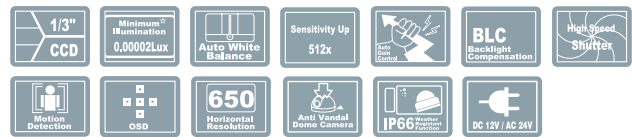

SPECIFICATIONS

MODEL	HT7248FFI
Image Pick-Up Device	1/3" Sony Super HAD II CCD
TV System	NTSC, PAL
Total Pixels	NTSC=811(H) * 508(V) / PAL=795(H) * 596(V)
Effective Pixels	NTSC=768(H) * 494(V) / PAL=752(H) * 582(V)
Scanning Frequency	NTSC=15.734KHz(H) & 59.94Hz(V) / PAL=15.625KHz(H) & 50.00Hz(V)
Scanning System	2:1 Interlace
Synchronization	Internal
Resolution	650TV Lines
Minimum Illumination	CDS OFF: 0.15 Lux, CDS ON: 0.00002 Lux
S/N Ratio	More than 52dB
Video Output	CVBS: 1.0Vp-p / 75Ω
Electronic Shutter Speed	NTSC=(1/60sec~1/120,000sec) / PAL=(1/50sec~1/120,000sec)
OSD	Available
WDR	On / Off (Level adjustable)
BLC	BLC / HLC / OFF
Day & Night	Color / BW / AUTO
Gain Control	Low / High / Off
White Balance	ATW / Outdoor / Indoor / Manual / AWC (1,700°K ~ 11,000°K)
Intensify	Auto / Off (Selectable x2 ~ x512)
Motion Detection	On / Off (8 Programmable Zones)
Privacy Masking	On / Off (12 Programmable Zones)
SPECO DNR	On / Off (Level adjustable)
Digital Zoom	On / Off (x1 ~ x16)
DIS (Digital Image Stabilization)	On / Off
Sharpness	On / Off (Level adjustable)
Flip / Mirror	On / Off
Power Supply	DC 12V / AC24V(Dual Voltage)
Power Consumption	DC 12V 250mA / AC24V 100mA
Lens	Focus free AI Motorized zoom Lens(2.8-10mm)
RS485(Optional)	PELCO-D, PELCO-P, BOSCH, HONEYWELL, VICON, PANA, STW(SPD)
Operational Temp.	-4°F~+140°F RH 95% Max
Storage Temp.	-4°F~+140°F RH 95% Max
Dimension	5.10"(Dia) * 3.46"(H)
Weight	1 lbs

CAMERA INSTALLATION

1) HTD8FFI

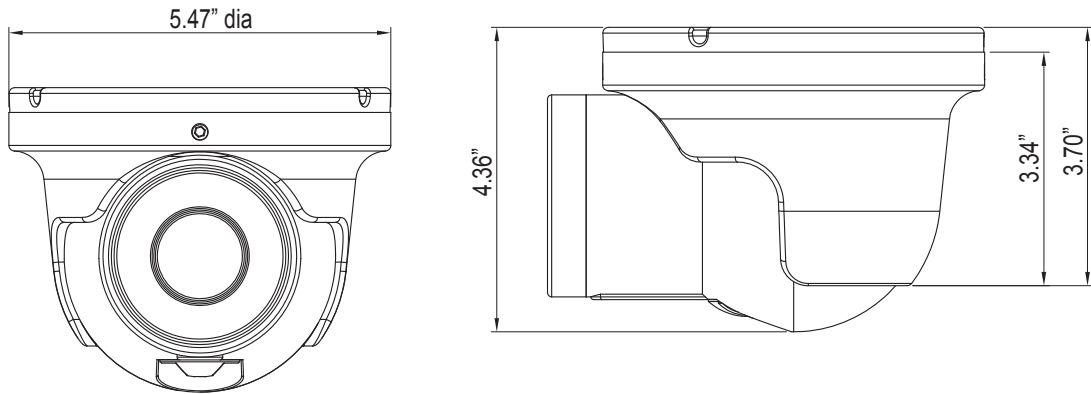

2) HTB11FFI

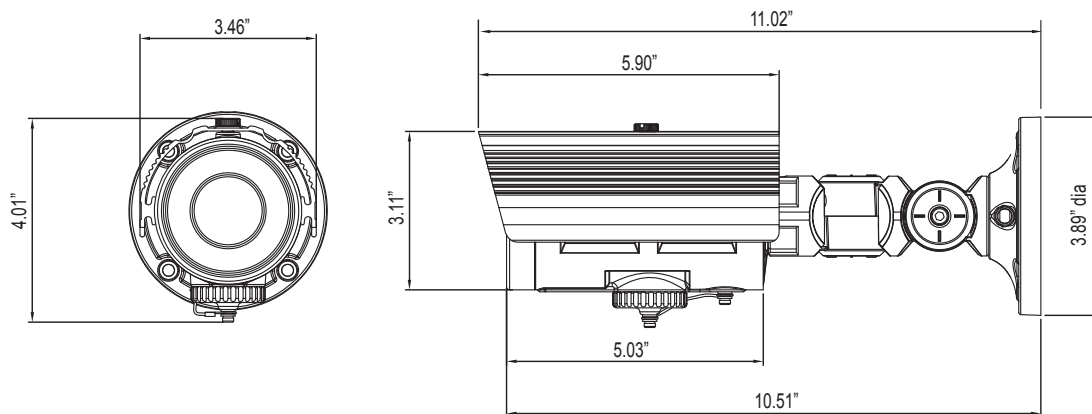

CAMERA INSTALLATION

3) HT7248FFI

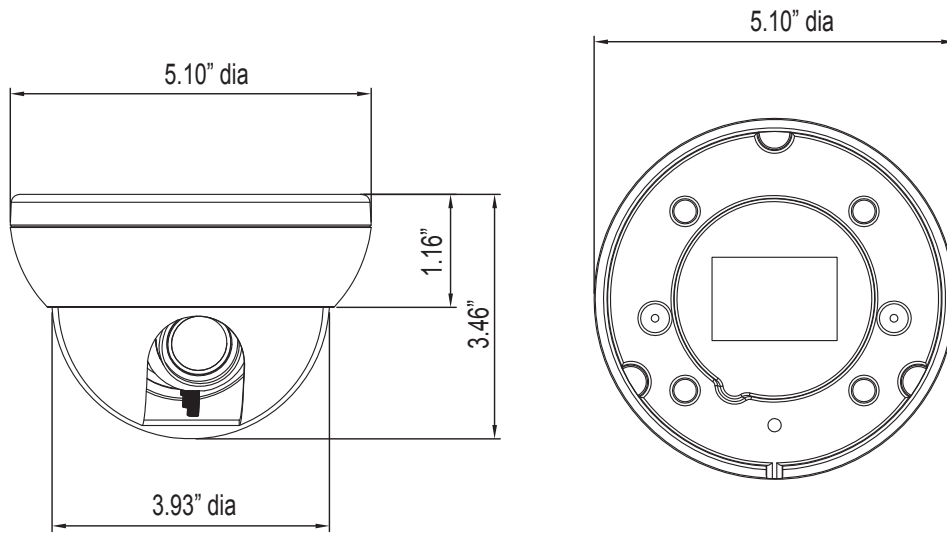

FEATURES

Now with "PRESETS"

PRESETS (Outdoor, Indoor, Elevator, Lobby, Hallway & Low Light)
Used for a quick and easy setup for the installation environment.

650TVL Resolution

Horizontal resolution of 650 TV lines is achieved by using a SONY Super-HAD CCD with 410,000 pixels, and a custom DSP yielding pictures with a high S/N ratio.

INTENSIFIER 3

More Powerful Performance in low light condition.
High quality Pictures to be captured in very low light condition.

WDR

More Powerful WDR in strong back lighting.
Your camera allows you to get a clear image.

SPECO DNR

The Intensifier camera has a DSP chip that can remove image noise efficiently showing clean images in low light conditions.

HLC (High Light Compensation)

This function reverses bright spots in the picture (such as headlights). This enables the entire system to do a better job of resolving and displaying grayscale information such as a license plate.

FEATURES

Motion Detection with Alarm Output

Built in motion detector with adjustable areas of coverage will
Send a signal to an external alarm device when motion is detected.

PRIVACY MASK

It also has the ability to mask up to 8 areas of the picture where
Viewing is not desired. Each zone can be independently
programmed via the OSD

STABILIZER

This function removes image jitter that is caused by vibrations in
the building and reduces the amount of hard drive space.

DIGITAL ZOOM

The picture could be enlarged by this function in digital.

DAY/NIGHT

The Intensifier camera can show color pictures in all lighting
conditions, or you can have it automatically switch to a B/W
picture in low light conditions

OSD

All camera functions are menu driven for easy use.

● Preset Mode

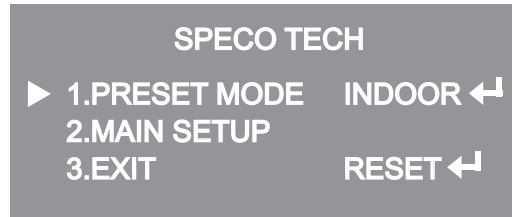

1. Preset : INDOOR / OUTDOOR / LOW LIGHT / HALLWAY / LOBBY / ELEVATOR.
– Used for a quick and easy setup for the installation environment.

● Menu Setup

1. Press the Function Setup switch.
– Main setup menu is displayed on the monitor screen.

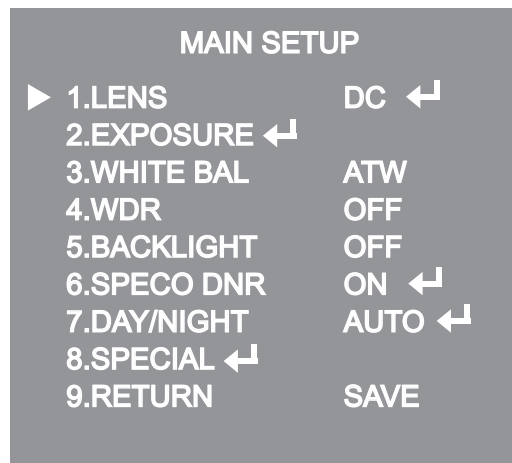

2. Select a desired function using the Function Setup switch.
– Place the cursor over a desired item.
3. Set up a selected item by using the Function Setup switch.
4. To finish the setting, select 'RETURN' and press the Function Setup switch.

NOTE

- An item with the ◀ icon also has sub menus. To select a sub menu, select an item with the icon and press the Function Setup switch.
- An item with the - - - icon is unavailable due to function settings.

● Lens Setting

Using this function, you can control the screen brightness.

1. When the SETUP menu screen is displayed, select 'LENS' by using the Function Setup switch so that the arrow indicates 'LENS'.
2. DC : You can adjust the minimum shutter and maximum value of ESC shutter mode.

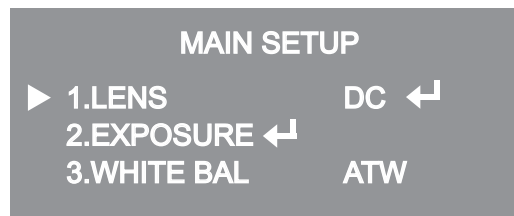

3. THE Lens mode has sub menu items as listed below.

- BRIGHTNESS : Adjusts the video brightness.
- FOCUS ADJ : To adjust the DC lens focus correctly, you must activate the Focus Settings mode under each lens menu. Activate the Focus Settings mode, adjust the lens focus, and then deactivate the settings mode.

NOTE
 ■ If color rolling occurs when using a DC lens, set Shutter to Fixed (---).

● Exposure Setting

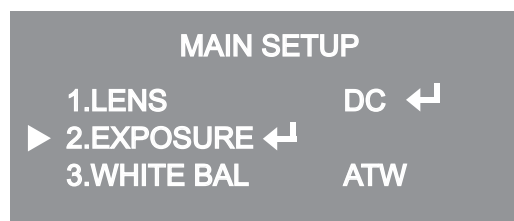

1. When the SETUP menu screen is displayed, select 'EXPOSURE' by using the Function Setup Switch.
2. Select a desired mode using the Function Setup switch.

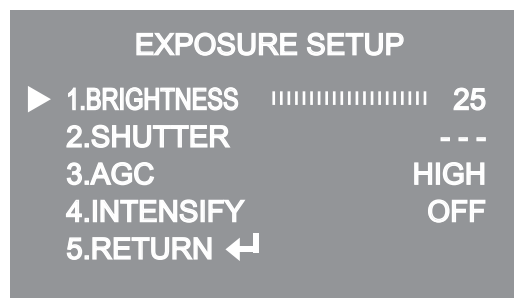

- ◆ SHUTTER : You can select either auto or manual shutter.
- * --- : Shutter speed is fixed at 1/60sec(1/50sec)
- * ESC : Select this to control the shutter speed automatically. If ESC is selected, the shutter speed is automatically controlled depending on the ambient illumination of the subject.
- * MANUAL : You can control shutter speed manually.
 (NTSC MODEL : 1/60~1/120,000, PAL MODEL : 1/50~1/120,000)
- * A,FLK : Select this when you see picture flicker, this can happen when the frequency of the local lighting clashes with the camera.

 **NOTE**

■ When the **SHUTTER** is set to **MANUAL** or **A.FLK** mode, **INTENSIFY** will be disabled.

- ◆ **AGC(AUTO GAIN CONTROL)** : The higher the gain level, the brighter the screen
– but the higher the noise.
- * **OFF** : Deactivates the AGC function.
- * **LOW** : Allows automatic gain control from 5.3dB to 32dB.
- * **HIGH** : Allows automatic gain control from 5.3dB to 37dB.
- ◆ **INTENSIFY** : When it is night or dark, the camera automatically detects the
light level and maintains a clear picture if this mode is activated.
- * **OFF** : Deactivates the INTENSIFY function.
- * **AUTO** : Activates the INTENSIFY function.
- ◆ **RETURN** : Select this to save the changes in the EXPOSURE menu and return
to the SETUP menu.

 **NOTE**

- If you press the **Function Setup** switch to '**AUTO**' mode, you can adjust brightness by
increasing or decreasing the shutter speed. (x2 ~ x512)
- Note that the higher the zoom level, the brighter the screen, but the more likely there
will be a ghosting effect.
- It is normal for **Noise, Spots and Whitish** symptoms to appear in **INTENSIFY** mode
when the **D-ZOOM** level is increased.

● White Balance (White Bal) Setting

Use the White Balance function to adjust the screen color.

1. When the **SETUP** menu screen is displayed, select '**White Bal**' by using the
Function Setup switch so that the arrow indicates '**White Bal**'.
2. Select a desired mode using the **Function Setup** switch.

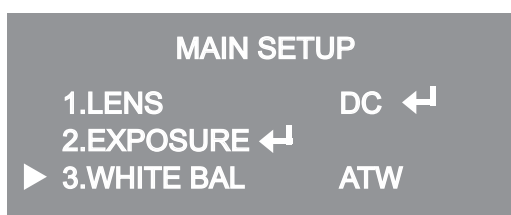

- ※ Select one of the following 5 modes, as appropriate for your purpose.
- ◆ ATW : Select this when the color temperature is between 1,700 ° K and 11,000 ° K.
- ◆ OUTDOOR : Select this when the color temperature is between 1,700 ° K and 11,000 ° K.
(sodium light inclusion)
- ◆ INDOOR : Select this when the color temperature is between 4,500 ° K and 8,500 ° K.
- ◆ MANUAL : Select this to fine-tune White Balance manually. Set White Balance first by using the ATW or AWC mode. After that switch to MANUAL mode, fine-tune the White Balance and then press the Function Setup switch.
- ◆ AWC→SET : To find the optimal luminance level for the current environment, point the camera towards a sheet of white paper and press the Function Setup switch. If the environment changes, readjust it.

NOTE

■ White Balance may not work properly under the following conditions. In this case select the AWC mode.

- ① When the color temperature of the environment surrounding the subject is out of the control range (e.g. clear sky or sunset).
- ② When the ambient illumination of the subject is dim.
- ③ If the camera is directed towards a fluorescent light or is installed in a place where illumination changes dramatically, the White Balance operation may become unstable.

● WDR Setting

WDR illuminates darker spots of an image while retaining the same light level for brighter spots to even out the overall brightness of images with high contrast between bright and dark spots.

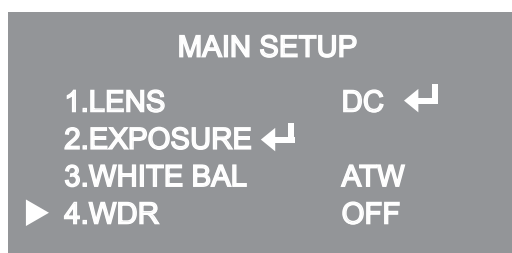

1. When the SETUP menu screen is displayed, select 'WDR' by using the switch so that the arrow indicates 'WDR'.
2. Use the switch to change the WDR level according to the contrast between bright and dark areas.

● Backlight Setting

Unlike conventional cameras, the 650Line Intensifier3™ Series are designed to deliver a distinctive subject and background at the same time, even when the subject is backlight, by using the features of the proprietary W-V DSP chip.

1. When the SETUP menu screen is displayed, select 'BACKLIGHT' by using the Function Setup switch so that the arrow indicates 'BACKLIGHT'.

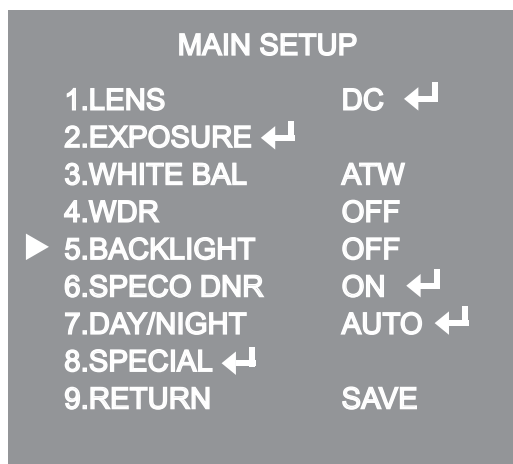

2. Select a desired mode using the Function Setup switch.

- ◆ BLC : Enables a user to directly select a desired area from a picture, and to view the area more clearly.
- ◆ HLC (High Light Compensation) : If the scene contains extremely bright light areas such as; from car headlights, the light can mask out much of the on-screen detail
 - LEVEL : Adjust level of the HLC function.
 - LIMIT : Enable to change the operating condition.
 - MASK COLOR/TONE : Change the color / transparency of the masking area.
(Black, Red, Blue, Cyan, Magenta)
 - TOP/BOTTOM/LEFT/RIGHT : Adjust the area to be enhanced
- ◆ OFF : Not being used

3. Select a desired mode using the Function Setup switch and press the Function Setup switch.

- ◆ Select 'BLC' to adjust the area to be enhanced then adjust the level.

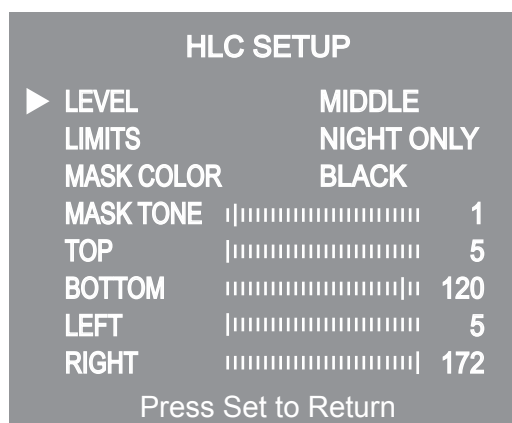
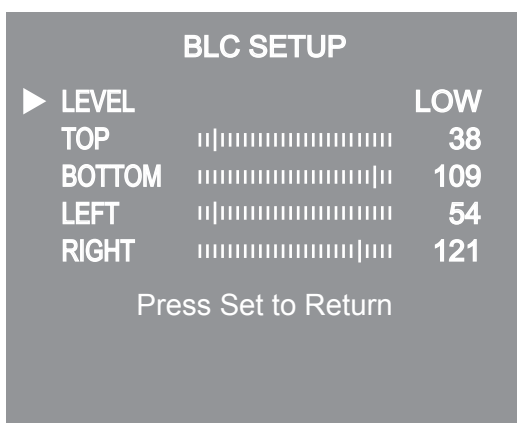

NOTE

- Because there can be a difference in the effectiveness of HLC according to the amount of light area in the screen, optimize the installation angle for the best HLC performance.
- When dark, the HLC is only activated when a bright light exceeding a specific size in NIGHT ONLY mode.
- The HLC is not activated in day light or when bright light is not present at night in NIGHT ONLY mode.
- BLC Function doesn't work in the B/W mode of the DAY/NIGHT menu.

● SPEC0 DNR Setting

This function reduces the background noise in a low luminance environment.

1. When the SETUP menu screen is displayed, select 'SPEC0 DNR' by using the Function Setup switch so that the arrow indicates 'SPEC0 DNR'.

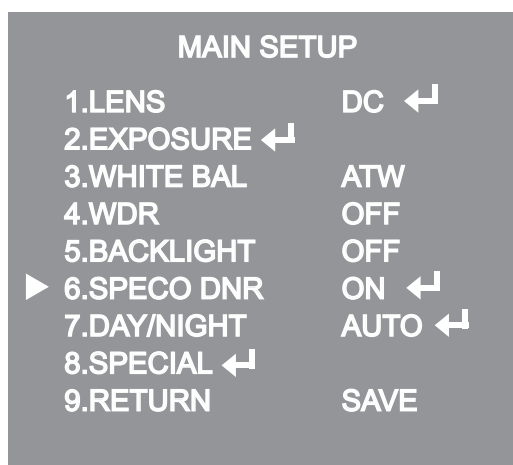

2. Select a desired mode using the Function Setup switch.

- ◆ OFF : Deactivates SPEC0 DNR. Noise is not reduced.
- ◆ ON : Activates SPEC0 DNR so that noise is reduced.

3. Set the SPEC0 DNR mode to 'ON' and press the Function Setup switch. Then you can adjust the noise reduction level.

NOTE

- You cannot set the SPEC0 DNR to 'ON' or 'OFF' when the AGC mode of the EXPOSURE menu is 'OFF'.
- When adjusting the noise reduction level in the SPEC0 DNR mode, remember that the higher the level set, the more the noise level will be reduced, as will the brightness of the image.

● Day/Night Setting

You can display pictures in color or black and white.

1. When the SETUP menu screen is displayed, select 'DAY/NIGHT' by using the Function Setup switch so that the arrow indicates 'DAY/NIGHT'.

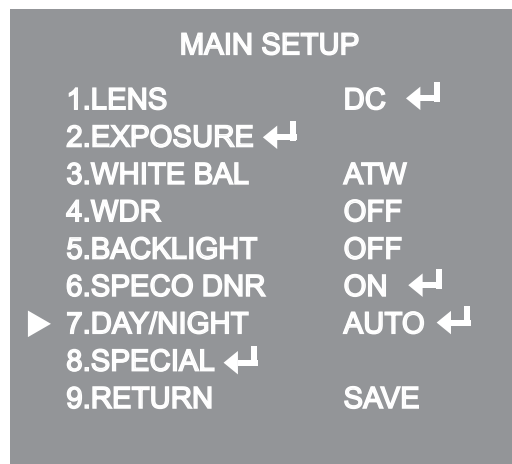

2. Select a desired mode using the Function Setup Switch according to the picture display you want.

- ◆ COLOR : The picture is always displayed in color.
- ◆ B/W : The picture is always displayed in black and white.
- BURST MODE : You can turn on or off the burst signal on B/W mode.

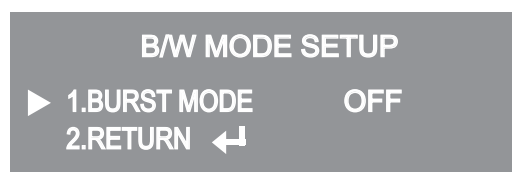

◆ **AUTO** : The mode is switched to 'Color' in a normal environment, but switches to 'B/W' mode when ambient illumination is low. To set up the switching time for AUTO mode, press the Function Setup switch. You can turn on or off the burst signal on B/W mode.

- **BURST MODE** : You can turn on or off the burst signal on B/W mode.
- **DURATION** : You can select brightness of illumination about changing the day/night mode.
- **DWELLTIME** : You can select the duration time about changing the day/night mode.
→3s, 5s, 7s, 10s, 15s, 20s, 30s, 40, 60s

AUTO SETUP	
▶ 1.BURST MODE	ON
2.COLOR→BW	
DURATION	FAST
DWELL TIME	3SEC
3.B/W→COLOR	
DURATION	FAST
DWELL TIME	10SEC
4.RETURN ◀	

	COLOR→B/W	B/W→COLOR
FAST	2.5 lux	5 lux
SLOW	1 lux	10 lux

* The day/night switching point of the camera can be adjusted.

NOTE

■ When **AGC** in the **EXPOSURE** menu is 'OFF', '---' mode operates as like selecting 'COLOR' mode and 'AUTO' mode can not be selected.

● Special Setting

1. When the **SETUP** menu screen is displayed, select 'SPECIAL' by using the Function Setup switch so that the arrow indicates 'SPECIAL'.

MAIN SETUP	
1.LENS	DC ◀
2.EXPOSURE ◀	
3.WHITE BAL	ATW
4.WDR	OFF
5.BACKLIGHT	OFF
6.SPECO DNR	ON ◀
7.DAY/NIGHT	AUTO ◀
▶ 8.SPECIAL ◀	
9.RETURN	SAVE

2. Select a desired mode using the Function Setup switch.

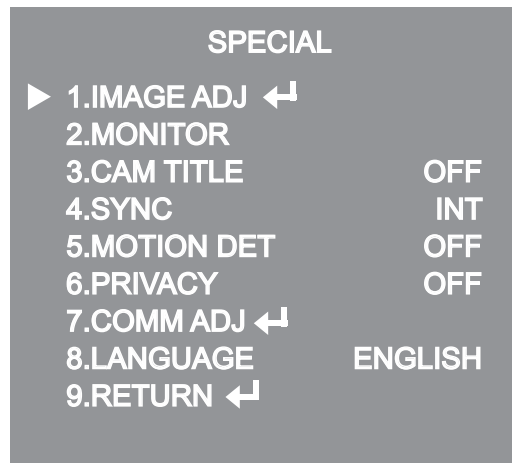

◆ IMAGE ADJ. :

- 1) When the SETUP menu screen is displayed, select 'IMAGE ADJ' by using the Function Setup switch so that the arrow indicates 'IMAGE ADJ'.
- 2) Select a desired mode using the Function Setup switch.

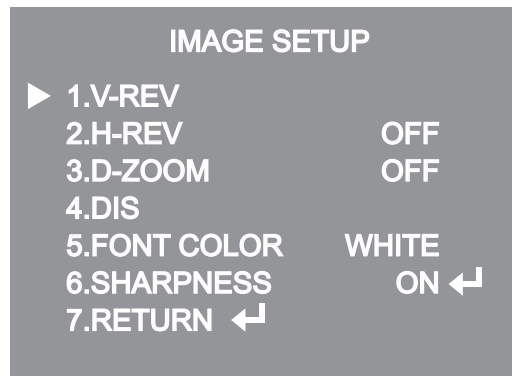

- * V-REV : You can flip the picture vertically on the screen.
- * H-REV : You can flip the picture horizontally on the screen.
- * D-ZOOM : You can use a digital zoom of x1 ~ x16.
- * DIS (Digital Image Stabilizer) : This function mitigates any picture movement due to external factors such as wind.
- * FONT COLOR : You can change the OSD font color. (White, Yellow, Green, Red, Blue)
- * SHARPNESS : As you increase this value, the picture outline becomes stronger and clearer.
Adjust this value appropriately depending on the sharpness of the picture.
- * RETURN : Select this to save the settings for the IMAGE ADJ menu and to return to the SETUP menu.

NOTE

- When the V-REV or H-REV mode is enabled, the text on the screen does not flip.
- If you increase the SHARPNESS level too high, the picture may become distorted or noise may appear.

◆ MONITOR : Please change the settings value of video appropriate to your monitor.

- 1) LCD : Please select this menu item when using a LCD monitor.
- 2) CRT : Please select this menu item when using a CRT monitor.
- 3) USER : Please use this menu item when using a monitor other than standard ones. You can change the gamma, PED level, and color gain in the sub menus.

◆ CAM TITLE : If you enter a title, the title will appear on the monitor.

- 1) If the SPECIAL menu screen is displayed, use the Function Setup switch so that the arrow indicates 'CAM TITLE'.
- 2) Set it to 'ON' by using the Function Setup switch.
- 3) Press the Function Setup switch.
- 4) Use the Function Setup switch to move to a desired letter and select the letter by pressing the Function Setup switch. Repeat this to enter multiple letters. You can enter up to 15 letters.
- 5) Enter a title, move the cursor to 'POS' and press the Function Setup switch. The entered title appears on the screen. Select the position to display the title on the screen by using the Function Setup switch and press the Function Setup switch. When the position is determined, select 'END' and press the Function Setup switch to return to the SPECIAL menu.



NOTE

- When the CAM TITLE menu is 'OFF', no title will be displayed on the monitor screen even if you enter one.
- Only English is available in this mode.
- If you move the cursor to CLR and press the Function Setup switch, all the letters are deleted. To edit a letter, change the cursor to the bottom left arrow and press the Function Setup switch. Move the cursor over the letter to be edited, move the cursor to the letter to be inserted and then press the Function Setup switch.

◆ SYNC : In areas where the supply is at 60Hz(NTSC), 50Hz(PAL), you can synchronize the output phase of multiple cameras using the power synchronization function (Line-Lock) without using a synchronization signal generator.

- INT : Internal Synchronization Type
- L/L : Power Synchronization Type, Line-lock
- * Press the Function Setup switch,
- * You can select a desired phase from 0 to 359 when select 'phase'.

NOTE

- When using AC power at 60Hz(NTSC), 50Hz(PAL), frequency, you can use the L/L type synchronization.
- When the power is DC 12V, the SYNC menu is fixed to the 'INT' mode.

◆ MOTION DET :This product has a feature that allows you to observe movement of objects in 8 different areas on the screen, and the words 'MOTION DETECTED' appear on the screen when movement is detected. Activity can be monitor more efficiently.

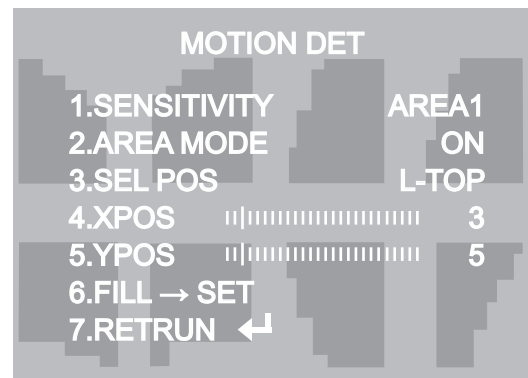

1) When the SPECIAL menu screen is displayed, press the Function Setup switch so that the arrow indicates 'MOTION DET' .

2) Set up the mode using the Function Setup switch,

- SENSITIVITY : You can select up to 8 MD areas. When SENSITIVITY number is high, motion detection sensitivity is increased to recognize even small movement.
- AREA MODE : Determines whether to use the MD area selected in SENSITIVITY.
- SEL POS : Determines which of the 4 vertices of each MD area is to be used.
- XPOS : Determines the coordinate of the horizontal axis for SEL POS.
- YPOS : Determines the coordinate of the vertical axis for SEL POS.
- FILL→SET : Fills in a selected MD area. The color of the area can be selected from brown, orange, blue, cyan, green, yellow, magenta and red.
- RETURN : Select this to save the MOTION DET menu settings and return to the SPECIAL menu.

◆ PRIVACY : Mask an area you want to hide on the screen.

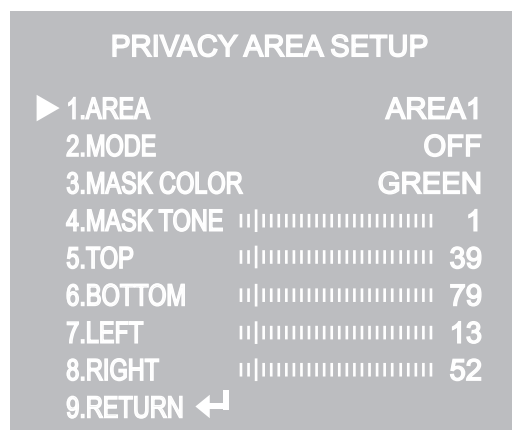

1) When the SPECIAL menu screen is displayed, press the Function Setup switch so that the arrow indicates 'PRIVACY'.

2) Set up the mode using the Function Setup switch.

- AREA : You can select up to 12 PRIVACY areas.
- MODE : Determines whether to use the area selected in the AREA.
- MASK COLOR : Determine area color. You can select Green, Red, Blue, Black, White, Gray.
- MASK TONE : Adjust the brightness of MASK COLOR.
- TOP/BOTTOM/LEFT/RIGHT :Adjust the size and position of the selected area.
- RETURN : Select this to save the PRIVACY menu settings and return to the SPECIAL menu.

◆ COMM ADJ

COMM ADJ	
1.CAM ID	1
2.BAUD RATE	2400
3.UART MODE	8-N-1
4.RET PKT	ENABLE
5.DISP ID	OFF
▶ 6.PROTOCOL	PELCO-D ←
7.RETURN	

- CAM ID : 1~255
- BAUD RATE : 2400, 4800, 9600, 19200, 38400, 57600
- UART MODE : 8-N-1, 8-E-1, 8-O-1
- RET PKT : ENABLE, DISABLE
- DISP ID : OFF, ON
- PROTOCOL : PELCO-D, PELCO-P, BOSCH, HONEYWELL, VICON, PANA, STW(SPD)
- RETURN

● RETURN Setting

Select a desired RETURN mode using the Function Setup Switch.

- SAVE : Save the current settings and RETURN the MAIN SETUP menu.
- NOT SAVE : Do not save the current settings and RETURN the MAIN SETUP menu.
- RESET : Resets the camera settings to the factory defaults. Language, Communication and Monitor Settings are not initialized.

● Trouble Shooting

PROBLEM	POSSIBLE CAUSE
Nothing appears on the screen.	<ul style="list-style-type: none"> ☞ Check the power cable, power supply output and video connection between the camera and monitor.
The image on the screen is dim.	<ul style="list-style-type: none"> ☞ Are the camera lens or the lens glass dirty? Clean the lens / glass with a soft clean cloth. ☞ Adjust the monitor controls, as required. ☞ If the camera is facing a very strong light, change the camera position. ☞ Adjust the lens focus.
The image on the screen is dark.	<ul style="list-style-type: none"> ☞ Adjust the contrast control of the monitor. ☞ If there is an intermediate device, correctly set the 75Ω/Hi-z.
The camera is not working properly and the surface of the camera is hot.	<ul style="list-style-type: none"> ☞ Check the camera is correctly connected to an appropriate regulated power source.
Motion Detection is not activated.	<ul style="list-style-type: none"> ☞ Has MOTION DET been set to ON in the menu? ☞ Has MD AREA been properly defined?
The color of the picture is not correct.	<ul style="list-style-type: none"> ☞ Check the settings in WHITE BALANCE menu.
The image on the screen flickers.	<ul style="list-style-type: none"> ☞ Make sure that the camera isn't facing direct sunlight or fluorescent lighting. If necessary, change the camera position.
The INTENSIFY does not work.	<ul style="list-style-type: none"> ☞ Check that the AGC setting in the EXPOSURE menu is't set to OFF. ☞ Check the EXPOSURE menu and make sure SHUTTER is set to-----.



LIMITED WARRANTY - VIDEO PRODUCTS

THIS WARRANTY IS VALID ONLY ON PRODUCTS PURCHASED AND USED IN THE UNITED STATES OF AMERICA AND CANADA. THIS WARRANTY APPLIES ONLY TO THE ORIGINAL USER.

SUBJECT TO CONDITIONS AND EXCLUSIONS FOUND BELOW, THIS PRODUCT IS WARRANTED AGAINST MANUFACTURING DEFECTS IN MATERIAL AND WORKMANSHIP FOR THE FOLLOWING PERIOD FOR PARTS AND LABOR:

SPECO TECHNOLOGIES CAMERAS.....	5 YEARS	DVRs.....	3 YEARS
SPECO TECHNOLOGIES IP CAMERAS.....	2 YEARS	NVRs	3 YEARS
SPECO PTZ AND VL CAMERAS.....	1 YEAR	BALANCE OF	
SPECO TECHNOLOGIES MONITORS.....	1 YEAR	SPECO TECHNOLOGIES LINE.....	1 YEAR
IR LEDS	90 DAYS		

SPECO TECHNOLOGIES WILL REPAIR OR REPLACE (AT OUR DISCRETION) ANY PARTS FOUND TO BE DEFECTIVE FOR THE WARRANTY PERIOD SPECIFIED. WE WILL PROVIDE A REPLACEMENT FOR ANY DEFECTIVE PART.

CONDITIONS

- 1. YOU MUST OBTAIN A RETURN AUTHORIZATION (RA) NUMBER FOR ANY MERCHANDISE BEING RETURNED TO SPECO TECHNOLOGIES, WHETHER FOR RETURN/EXCHANGE OR REPAIR, WHETHER IN OR OUT OF WARRANTY.**
2. THIS WARRANTY WILL BE HONORED ONLY UPON PRESENTATION OF THE ORIGINAL DATED BILL OF SALE OR SALES SLIP.
3. TRANSPORTATION OF THE PRODUCT TO OUR SERVICE DEPARTMENT IS THE RESPONSIBILITY OF THE USER. REPAIRED OR REPLACED PRODUCT WILL BE RETURNED PREPAID DURING THE WARRANTY PERIOD.
4. SPECO TECHNOLOGIES DOES NOT AUTHORIZE ANY INTERNET OR MAIL ORDER PRODUCT SALES. IF A SPECO TECHNOLOGIES PRODUCT IS PURCHASED FROM AN UNAUTHORIZED DISTRIBUTOR OR OTHER SOURCE, INCLUDING RETAILERS, MAIL ORDER SELLERS AND ONLINE SELLERS, IT WILL NOT BE HONORED OR SERVICED UNDER THE EXISTING SPECO TECHNOLOGIES WARRANTY POLICY. ANY SPECO TECHNOLOGIES PRODUCT PURCHASED FROM THESE ONLINE MERCHANTS WILL VOID THE APPLICABLE WARRANTY AND IS INELIGIBLE FOR TECHNICAL SUPPORT. IF YOU HAVE QUESTIONS ABOUT A RESELLER, PLEASE CONTACT SPECO TECHNOLOGIES AT 1-800-645-5516 FOR A LIST OF UNAUTHORIZED DEALERS, VISIT: www.specotech.com/unauthorized.

EXCLUSIONS

1. THIS WARRANTY SHALL NOT COVER ADJUSTMENT OF CUSTOMER OPERATED CONTROLS AS EXPLAINED IN THE APPROPRIATE Model 's INSTRUCTION MANUAL OR PRODUCTS WHICH HAVE BEEN ALTERED, ABUSED, OR HAVE MISSING OR ALTERED SERIAL NUMBERS.
2. THIS WARRANTY SHALL NOT APPLY TO UNCRATING, SETUP, INSTALLATION, OR THE REMOVAL AND REINSTALLATION OF PRODUCTS AFTER REPAIR.
3. THIS WARRANTY SHALL NOT APPLY TO REPAIRS OR REPLACEMENTS NECESSITATED BY ANY CAUSE BEYOND THE RESULT OF MANUFACTURE INCLUDING, BUT NOT LIMITED TO, ANY MALFUNCTION, DEFECTS OR FAILURE CAUSED BY OR RESULTING FROM UNAUTHORIZED SERVICE OR PARTS, IMPROPER MAINTENANCE, MODIFICATION OR REPAIR BY THE USER, ABUSE, MISUSE, NEGLIGENCE, ACCIDENT, FIRE, FLOOD, OR OTHER ACTS OF NATURE, INCORRECT LINE VOLTAGE, DAMAGE OR IMAGE BURNS TO TELEVISION PICTURE TUBES CAUSED BY OR ATTRIBUTABLE TO THE USE OF ANY ACCESSORY, ELECTRONICS GAME OR DEVICE, OR DAMAGE CAUSED TO IMAGE PICKUP DEVICES BY EXCESSIVE LIGHT.

THE FOREGOING IS IN LIEU OF ALL OTHER EXPRESSED WARRANTIES AND WE DO NOT AUTHORIZE ANY PARTY TO ASSUME FOR US ANY OTHER OBLIGATION OR LIABILITY. IN NO EVENT SHALL WE BE LIABLE FOR INCIDENTAL OR CONSEQUENTIAL DAMAGES ARISING FROM THE USE OF THIS PRODUCT, OR FOR ANY DELAY IN THE USE OF THIS PRODUCT DUE TO CAUSES BEYOND OUR CONTROL. SOME STATES DO NOT ALLOW LIMITATIONS OF HOW LONG AN IMPLIED WARRANTY LASTS AND/OR DO NOT ALLOW THE EXCLUSION OR LIMITATION OF CONSEQUENTIAL DAMAGES. THE ABOVE LIMITATIONS ON IMPLIED WARRANTY AND CONSEQUENTIAL DAMAGES MAY NOT APPLY TO YOU.

THIS WARRANTY GIVES YOU SPECIFIC LEGAL RIGHTS. YOU MAY HAVE OTHER RIGHTS WHICH VARY FROM STATE TO STATE.

NOTE: FOR YOUR PROTECTION IN THE EVENT OF THEFT OR LOSS OF THIS PRODUCT, PLEASE FILL IN THE INFORMATION REQUESTED BELOW AND RETAIN WITH YOUR SALES RECEIPT.

MODEL NO.: _____ SERIAL NO.: _____
(LOCATED ON BACK OR BOTTOM OF UNIT)

DATE OF PURCHASE: _____

WHERE PURCHASED: _____ PURCHASE PRICE: _____

Speco Technologies 200 New Highway Amityville, NY 11701 www.specotech.com	FOR MORE INFORMATION REGARDING SERVICE OR RETURN, CALL US TOLL FREE: 1-800-645-5516 IN METRO NY: 631-957-8700
---	---

ALWAYS USE DISCRETION WHEN INSTALLING VIDEO AND/OR AUDIO SURVEILLANCE EQUIPMENT ESPECIALLY WHEN THERE IS AN EXPECTATION OF PRIVACY. INQUIRE REGARDING FEDERAL, STATE AND/OR LOCAL REGULATIONS APPLICABLE TO THE LAWFUL INSTALLATION OF VIDEO AND/OR AUDIO RECORDING OR SURVEILLANCE EQUIPMENT. PARTY CONSENT MAY BE REQUIRED.

▶ MEMO

▶ MEMO



**200 New Highway
Amityville, NY 11701
631-957-8700
1 800 645 5516
www.specotech.com**